

Assembly

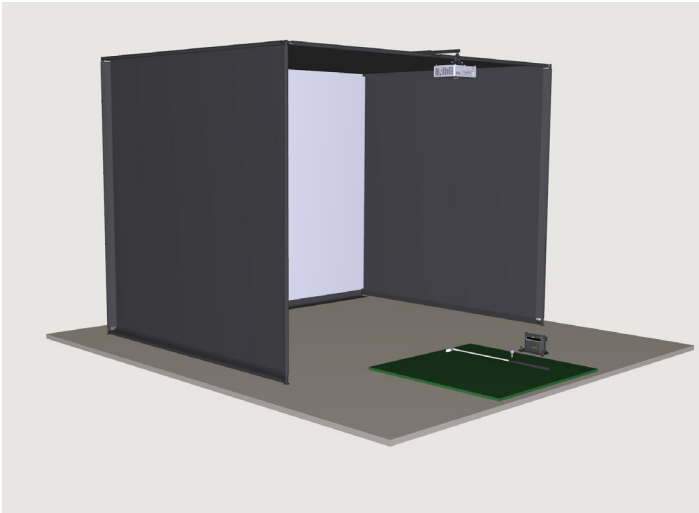

1

This procedure will assist you with assembling the Golf Simulator Par 5 Long Enclosure.

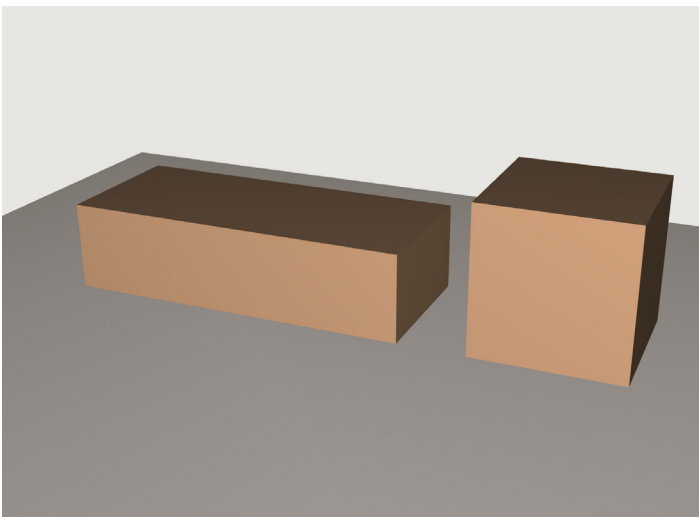

2

Your Golf Simulator Par 5 Long Enclosure will come in 2 separate cartons:

1 long carton for the Metal Frame and 1 rectangular carton for the Enclosure Material with Screen.

Please review the parts list and ensure you have all the equipment needed.

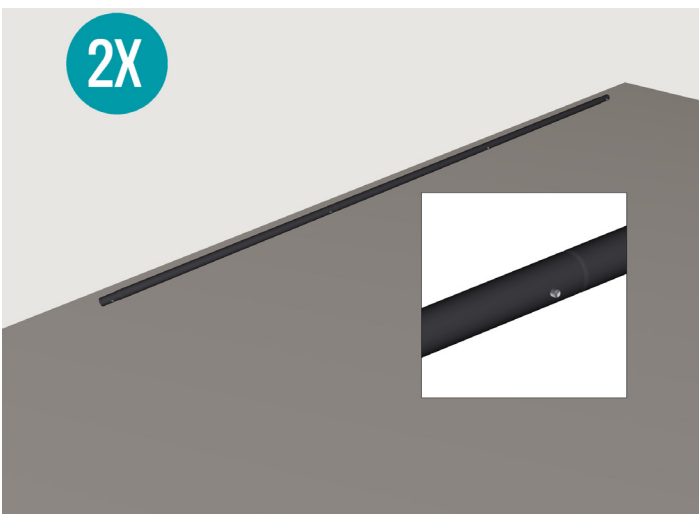

3

The following steps will assist you with assembling the Upper Frame.

Depress the pin on both ends of (1) Pole (B). Insert the Pole into the female ends of (2) Poles (A) as shown. Complete this step 2 times.

Assembly



4

For the Top Left Beam, depress the pins on both ends of the Pole Assembly (A, B, A). Slide (1) 105 Degree 3-Way Connector (1) over the front end and (1) 105 Degree 3-Way Connector (2) over the back end. Ensure the arrows on the Connectors are pointed toward the center as shown.

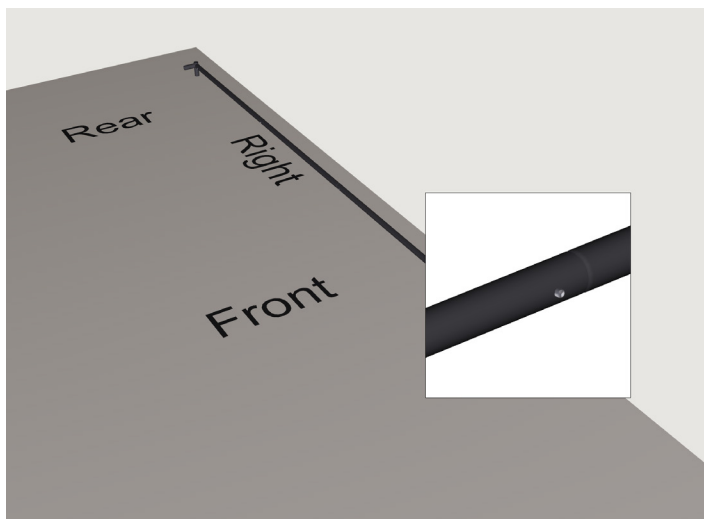

5

For the Top Right Beam, depress the pins on both ends of the Pole Assembly (A, B, A). Then, slide (1) 105 Degree 3-Way Connector (2) over the front end and (1) 105 Degree 3-Way Connector (1) over the back end. Ensure the arrows on the Connectors are pointed toward the center as shown.

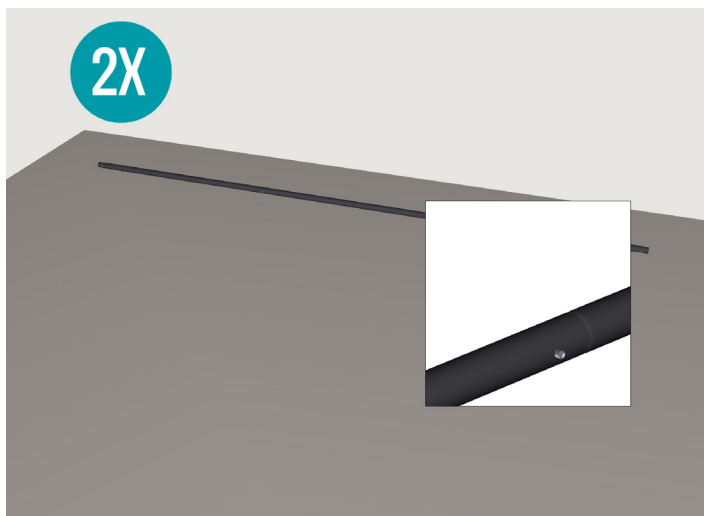

6

Depress the pins on both ends of (1) Pole (B). Insert the Pole into the female ends of (2) Poles (A) as shown. These Poles are for the top Front and Rear of the Enclosure. Complete this step 2 times.

Assembly

2X

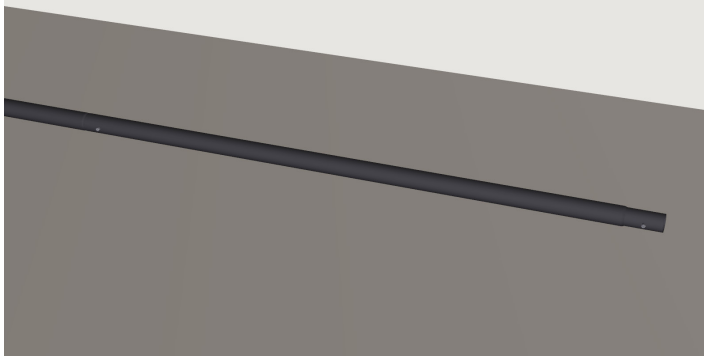

7

Depress the pin on the end of the Pole (A). Insert the Pole into the female end of (1) Pole (A) as shown. Complete this step 2 times.

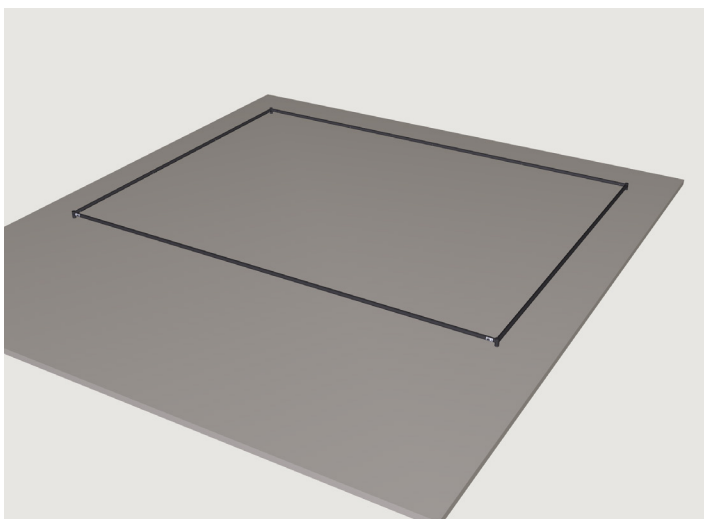

8

Depress the pins on the ends of the Pole Assemblies (A, B, A, A) and insert them into the 3-Way Connectors as shown.

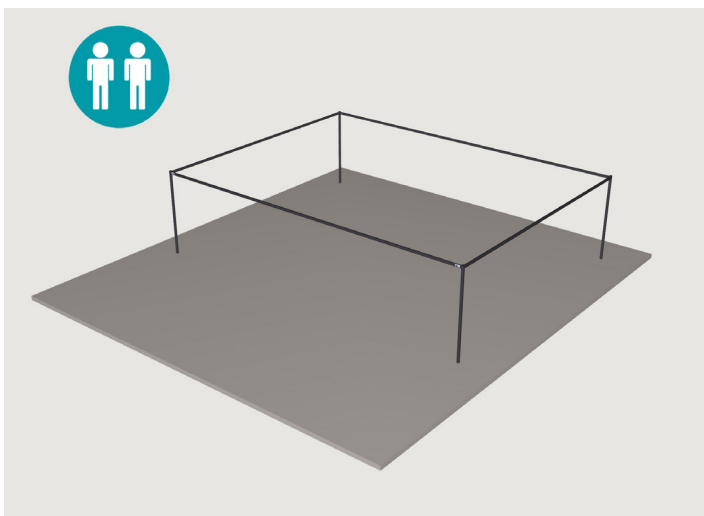

9

With the help of another adult, depress the pins on the male ends of (4) Poles (A) and insert them into the 3-Way Connectors as shown.

Assembly

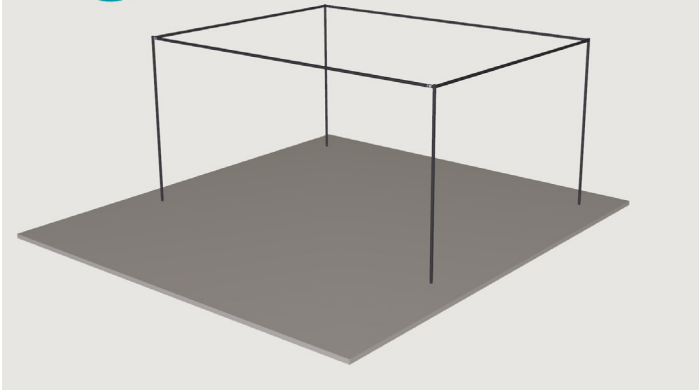

10

With the help of another adult, depress the pins on the male ends of (4) Poles (B) and insert them into the ends of each Pole (A) as shown.

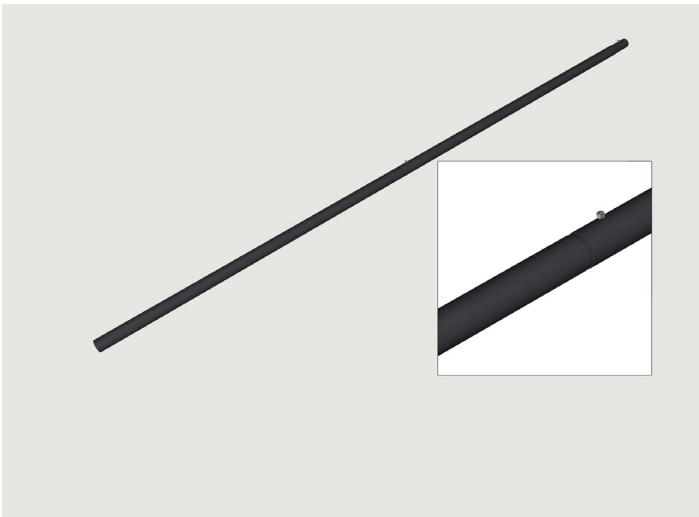

11

Depress the pin on the end of (1) Pole (A) and insert it into the female end of (1) Pole (A) as shown.

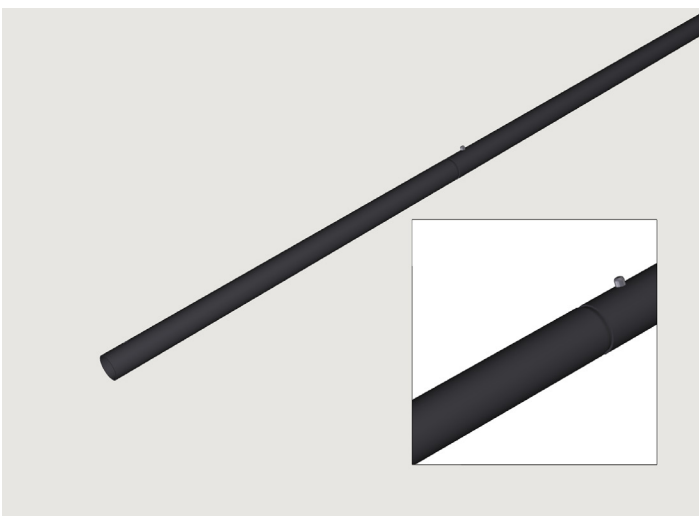

12

Depress the pin on the end of (1) Pole (C) and insert it into the female end of Pole (A) as shown.

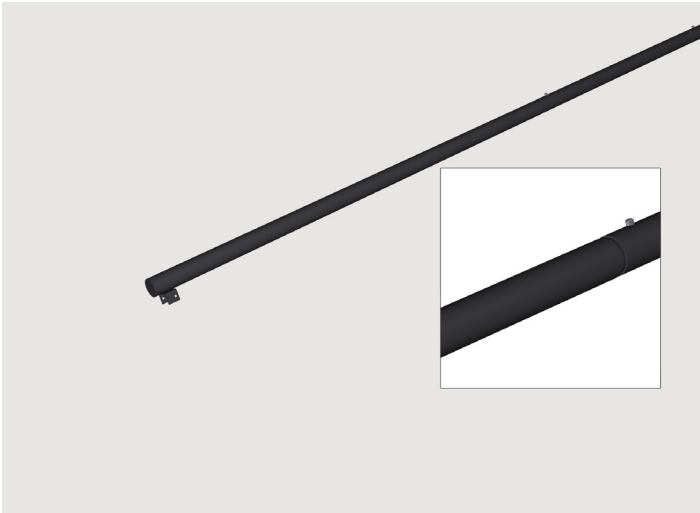

13

Depress the pin on the end of (1) Pole (F) and insert it into the female end of Pole (C) as shown.

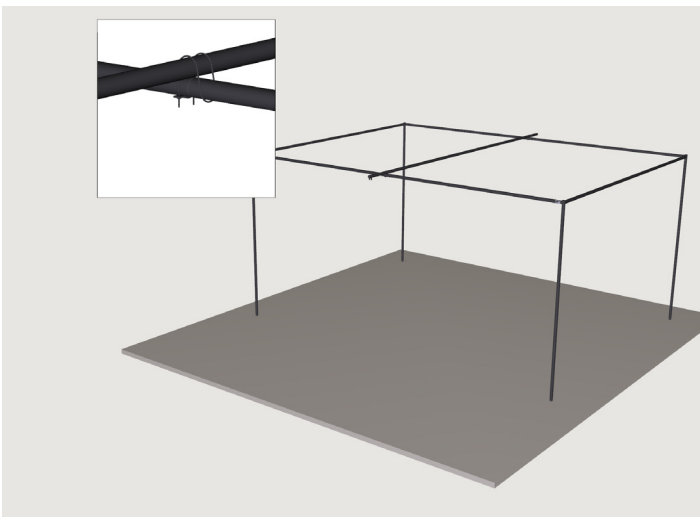

14

Attach (2) Crossover Clamps (X) to the Frame Assembly and mount the Pole Assembly (A, A, C, F) as shown.

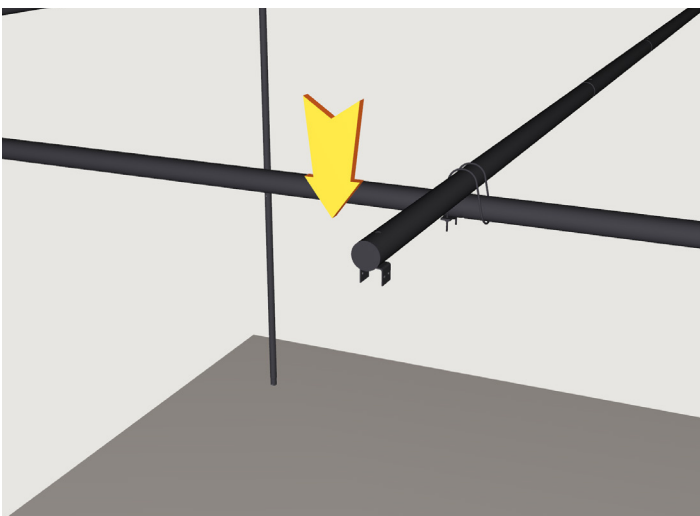

15

Note: Be sure the square gimbal piece of Pole (F) is oriented to face downward once the Pole Assembly is installed.

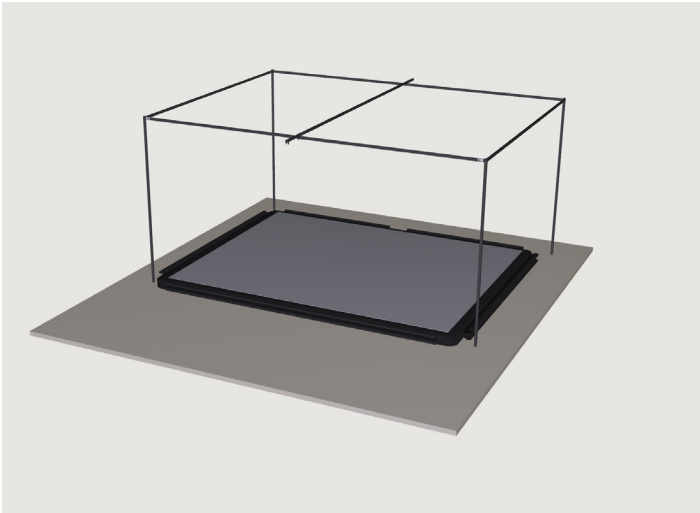

16

Place the Enclosure Material with Screen in the center of your enclosure area. Spread the black material out so the bottom of the Screen is identifiable. The white side should face the user when it is successfully installed.

WARNING: The Enclosure Material with Screen is not the hitting Screen.

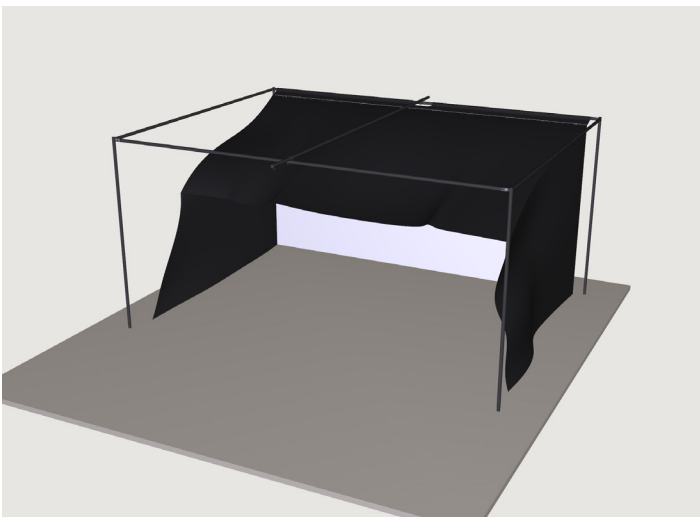

17

Secure the top rear edge of the Enclosure Material to the Upper Frame using the hook and loop attachments. Start at the rear before moving on to each side.

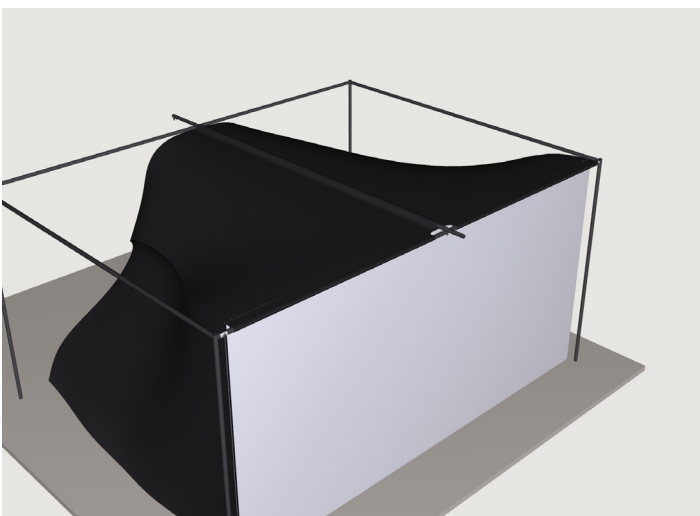

18

Secure the Enclosure Material to the Projector Pole using the hook and loop attachments.

Note: Leaving off the last 1/4 of the hook and loop attachment on the Projector Pole will allow you to hook and loop the impact screen on the inside of the Enclosure.

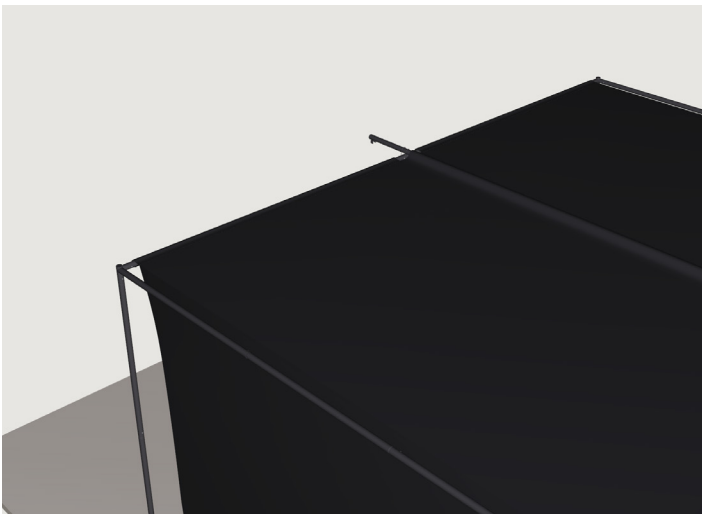

19

Secure the Enclosure Material to the Upper Front Frame using the hook and loop attachments.

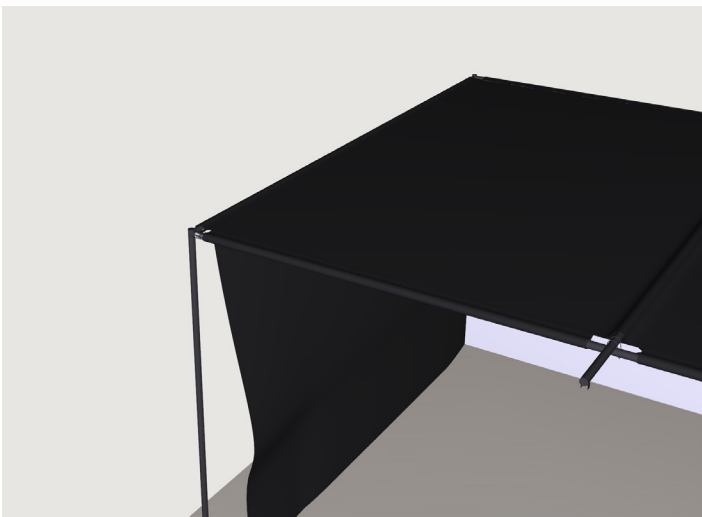

20

Secure the Enclosure Material to the Upper Left Frame using the hook and loop attachments.

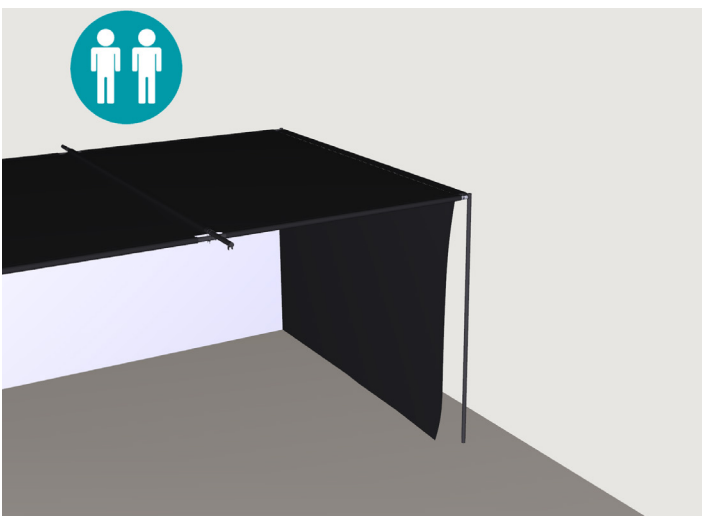

21

With the help of another adult, secure the Enclosure Material to the Upper Right Frame using the hook and loop attachments.

Note: This step requires at least 2 adults. Pull the fabric tight by grabbing the Material from the underside and twisting it over the top. If the hook and loop struggle to meet, pull firmly and twist from top to bottom to bring the hook and loop up easier.

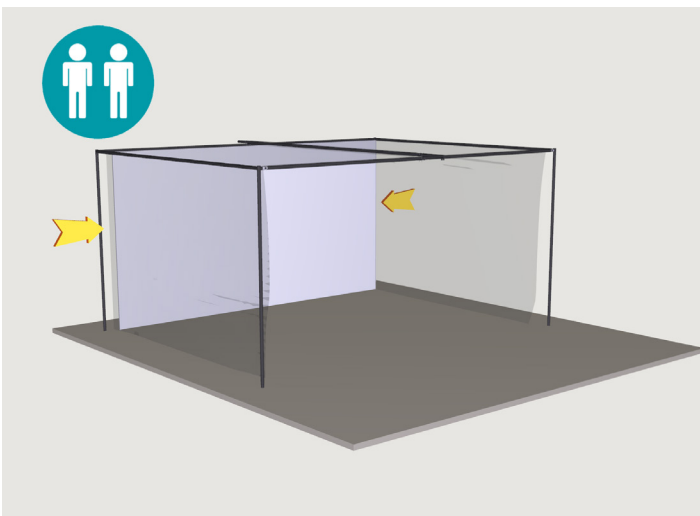

22

With the help of another adult, attach the Impact Screen to the inside of the Enclosure using the hook and loop attachments. One adult will push the Impact Screen outward, and one adult will push the outside of the Enclosure inward.

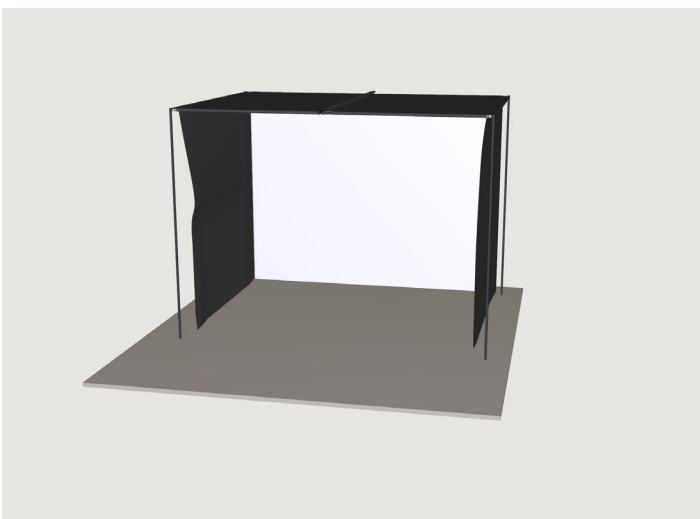

23

Lift one side of the Assembly and depress the pins on Poles (B). Insert the Poles into the female end of (2) Poles (A). Lift the other side of the Assembly and depress the pins on Poles (B). Insert the Poles into the female end of (2) additional Poles (A) as shown.

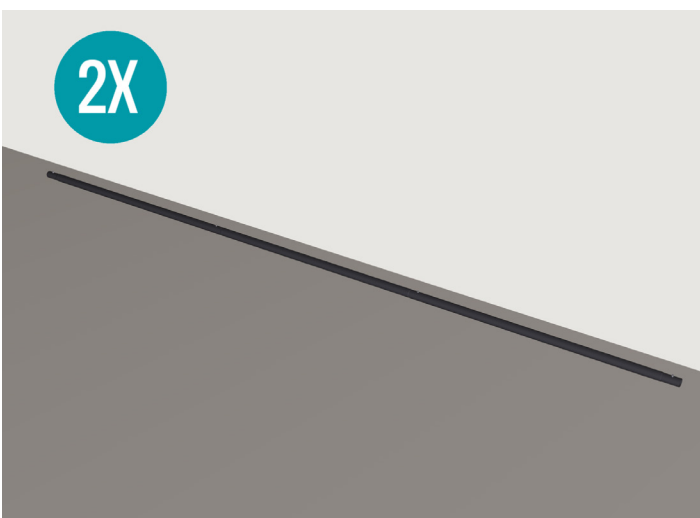

24

Depress the pin on both ends of (1) Pole (B) and insert it into the female ends of (2) Poles (A). Complete this step 2 times.

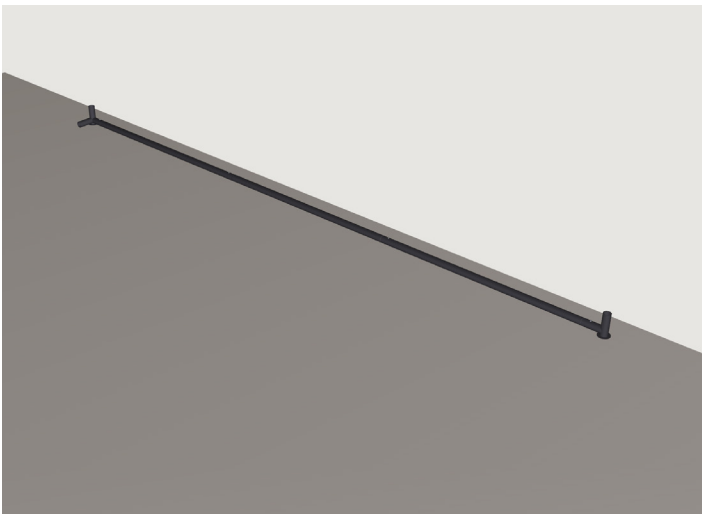

25

Depress the pins on both ends of the Pole Assembly (A, B, A). Insert Pole (A) into (1) 3-Way Feet Connector (5) and the other Pole (A) into (1) 2-Way Feet Connector (4) as shown. Ensure the 3-Way Feet Connector faces inward for the structure.

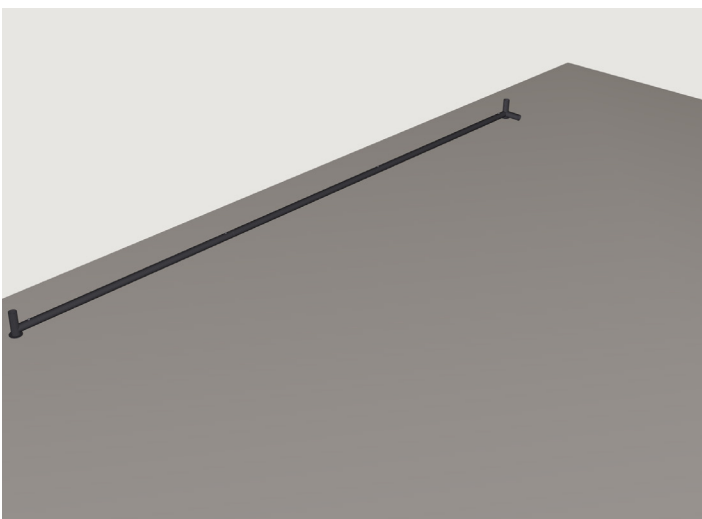

26

Depress the pins on both ends of the Pole Assembly (A, B, A). Insert Pole (A) into (1) 3-Way Feet Connector (5) and the other Pole (A) into (1) 2-Way Feet Connector (4) as shown. Ensure the 3-Way Feet Connector faces inward for the structure.

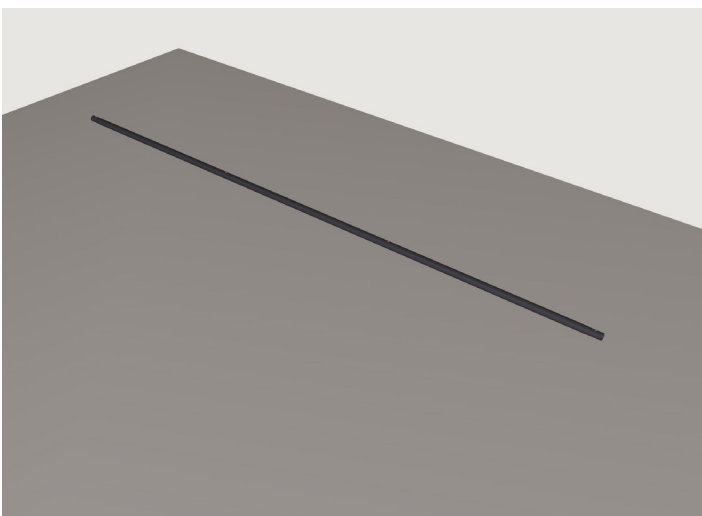

27

Depress the pins on both ends of (1) Pole (B). Insert the Pole into the female ends of (2) Poles (A) as shown.

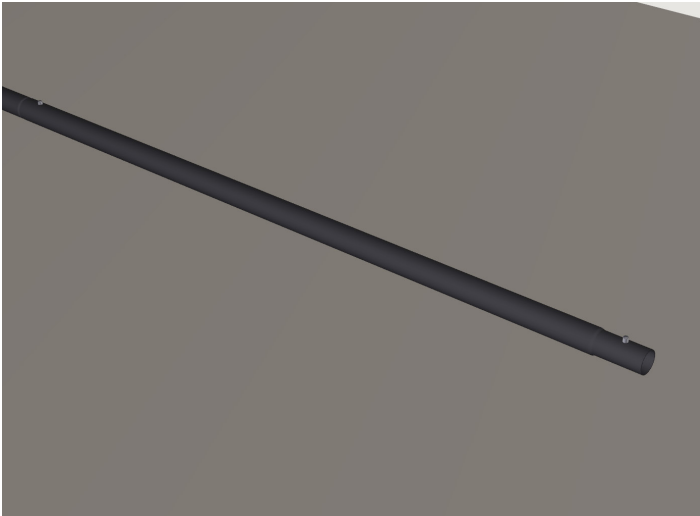

28

Depress the pin on the male end of Pole (A). Insert the Pole into the female end of (1) Pole (A) as shown.

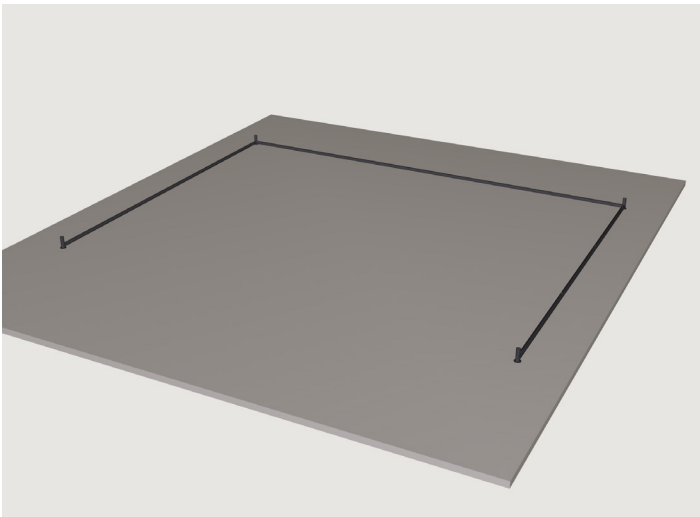

29

Depress the pins on the ends of the Pole Assembly (A, B, A, A) and insert them into the 3-Way Feet Connectors as shown.

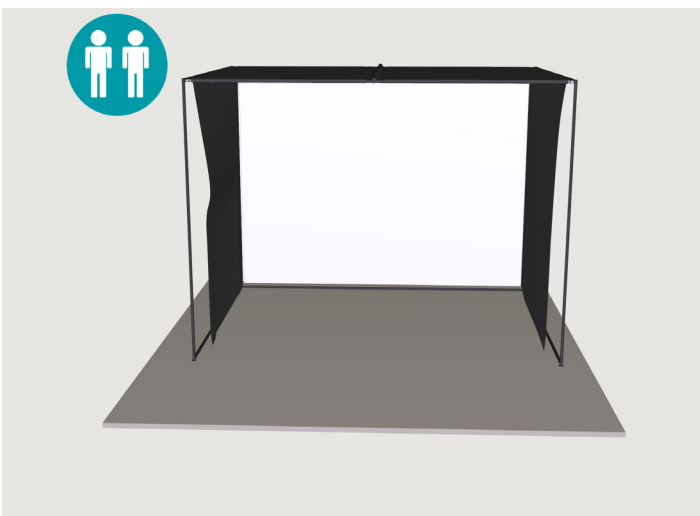

30

With the help of another adult, attach the Enclosure to the Base Assembly as shown. Insert one Pole at a time and ensure the push pins are secured when complete.

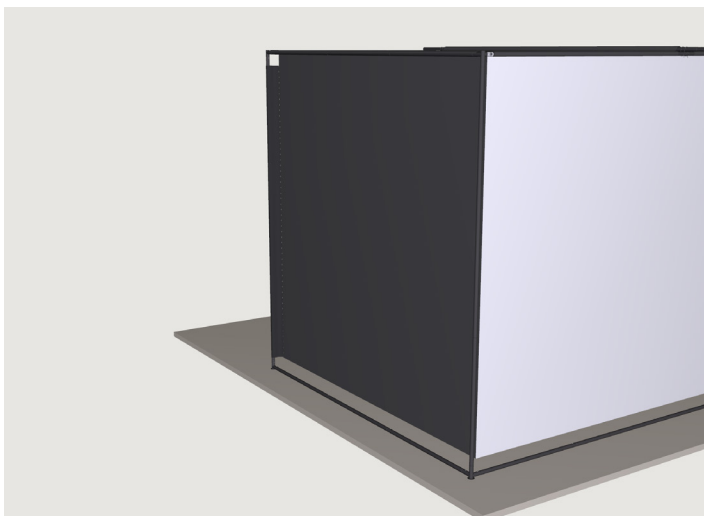

31

Secure the Enclosure Material to the Right Front Frame using the hook and loop attachments.

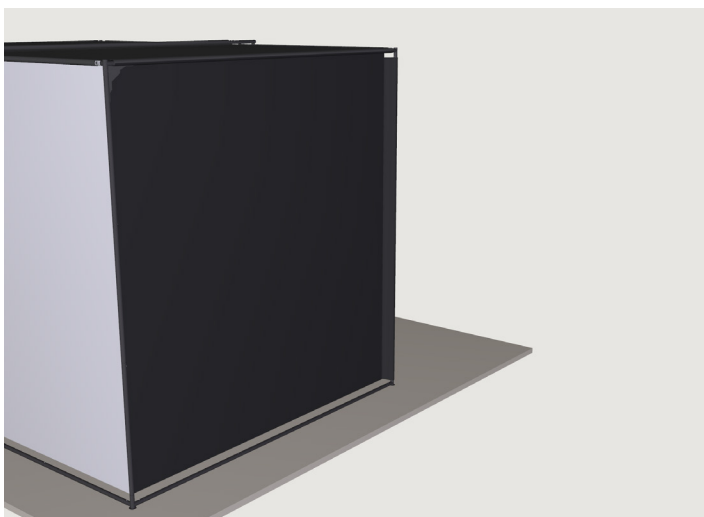

32

Secure the Enclosure Material to the Left Front Frame using the hook and loop attachments.

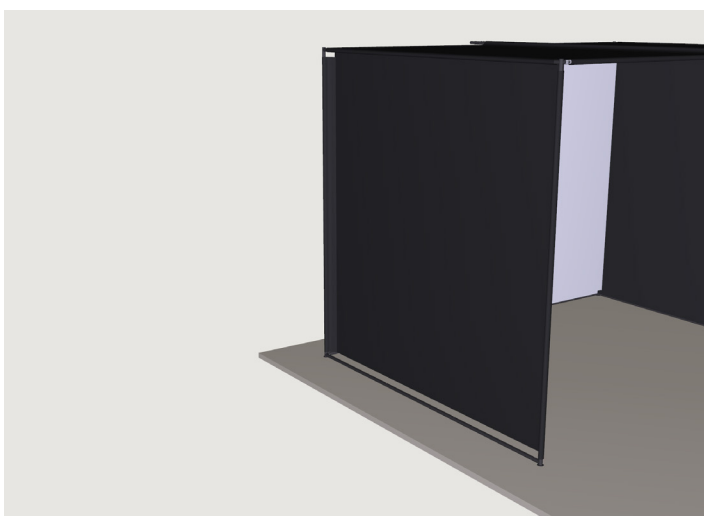

33

Secure the left side of the Enclosure Material to the Left side of the Frame using the hook and loop attachments.

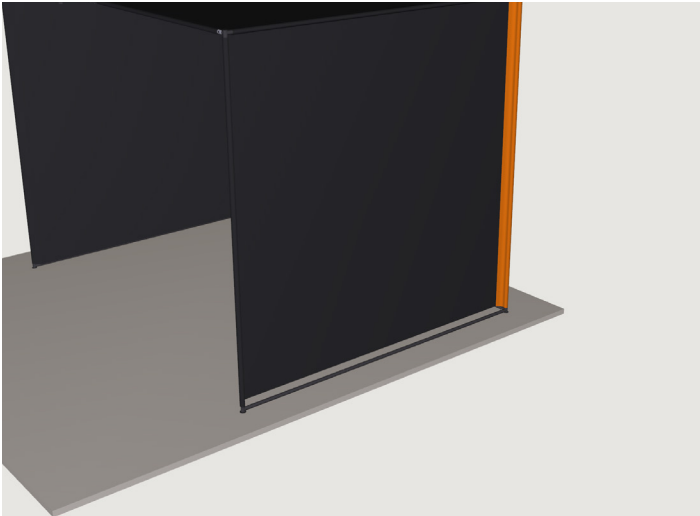

34

Secure the right side of the Enclosure Material to the Right side of the Frame using the hook and loop attachments.

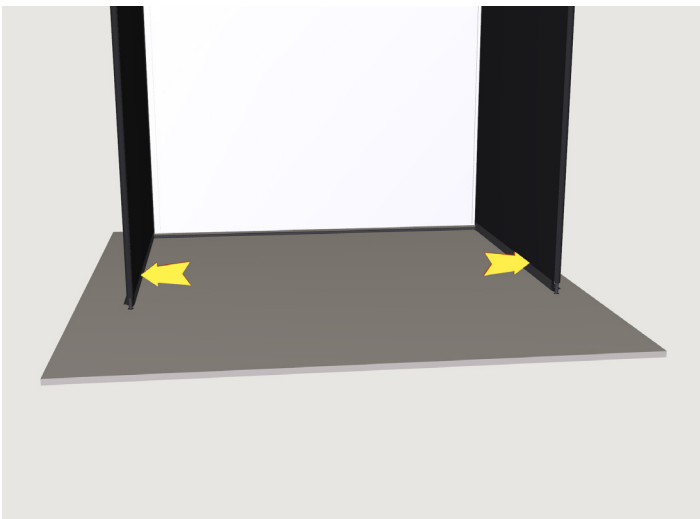

35

Wrap the bottom of the Enclosure Material underneath the base of the Frame as shown. Note: The rear exterior bottom may not connect completely. This will not jeopardize the integrity of the Enclosure, as long as the majority of the strip is wrapped.

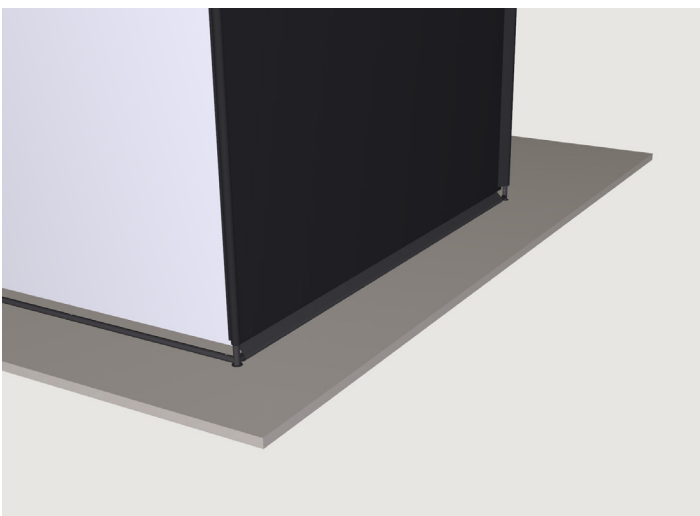

36

Secure the Enclosure Material to the Lower Left Frame using the hook and loop attachments.

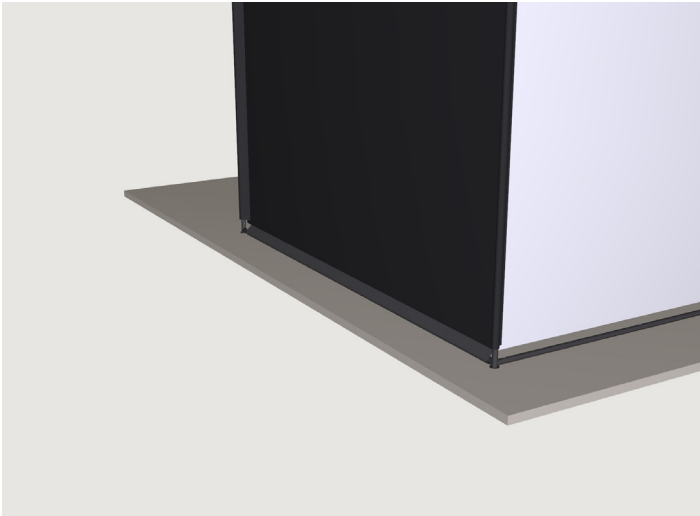

37

Secure the Enclosure Material to the Lower Right Frame using the hook and loop attachments.

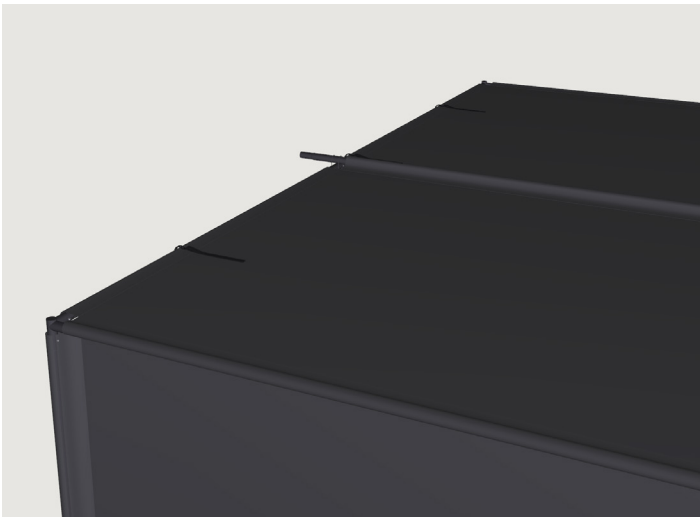

38

Slide (3) Clips onto the Straps on the top of the Enclosure Material with Screen. Connect the Straps and secure the Clips onto the rear Pole Assembly.

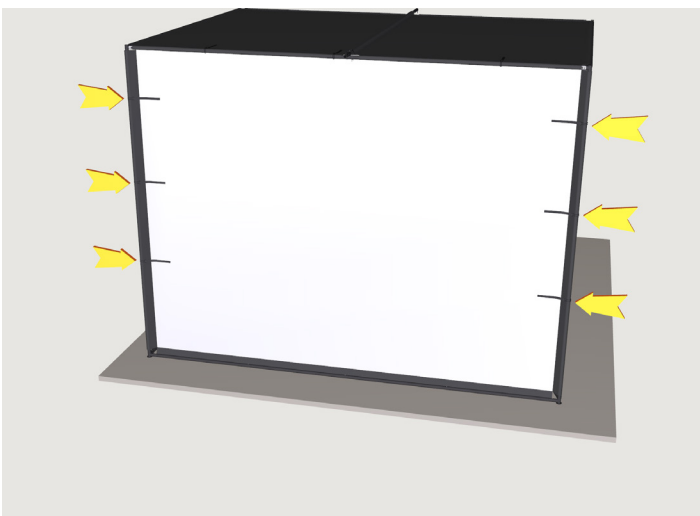

39

Slide (6) Clips onto the Straps on the backside of the Enclosure Material with Screen. Connect the Straps and secure the Clips onto the side Pole Assembly.

2X



40

Slide (1) Hook and Loop through (1) Clip as shown. Complete this step 2 times.

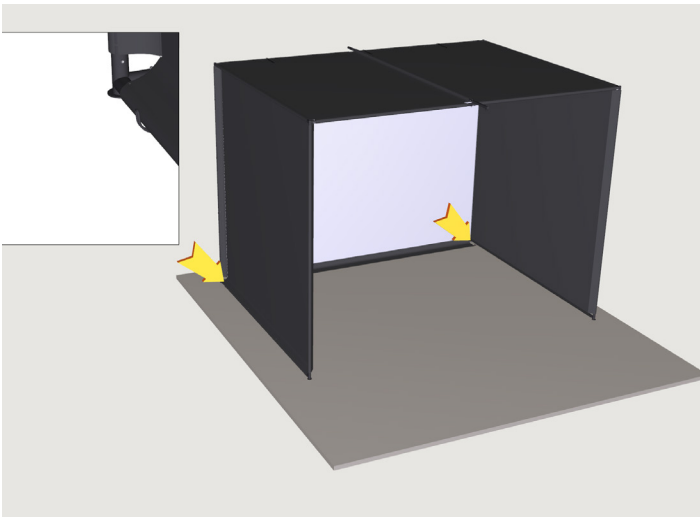

41

Attach the bottom Material Clips to the Frame.

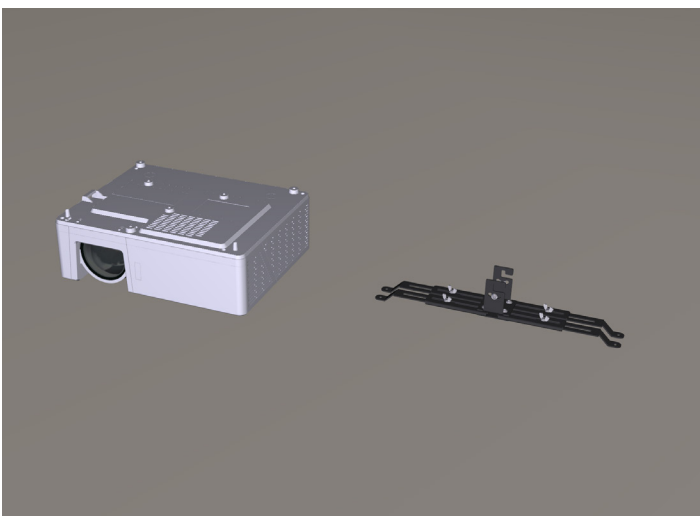

42

The following steps will assist you with the Projector installation.

Note: The installations will vary based on Projector and Projector Mount.

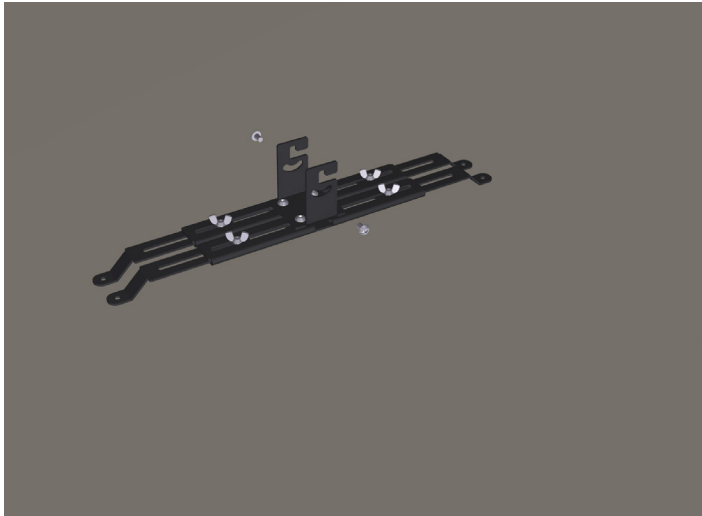

43

You will need to prepare the bracket to support the Projector. One arm is redundant and needs to be removed. You can loosen and remove the Projector Mount Screws on the hinge to access the screws beneath it more easily.



44

One arm must be removed. Remove the indicated Projector Mount Screw at the top to remove the arm.



45

Remove the indicated Wingnut and Projector Mount Screw to remove the Long Attachment as shown.

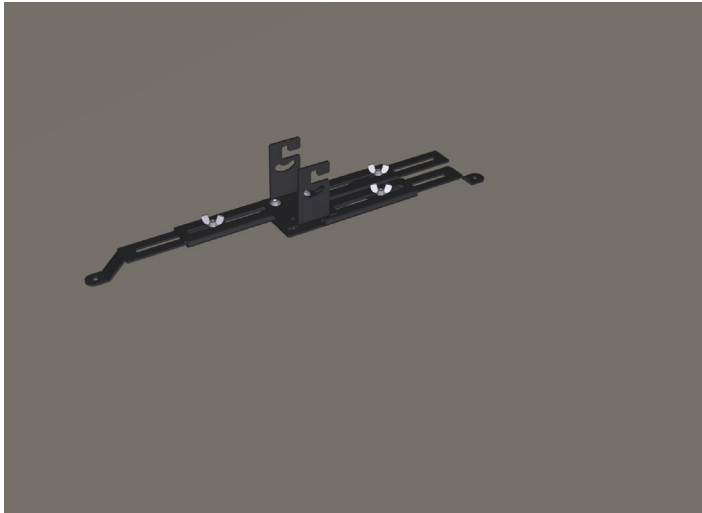

46

Rotate the Long Attachment 180 degrees and slide it back into the Bracket. Tighten the Wingnut and Projector Mount Screw in the approximate position shown to secure the Long Attachment.



47

Remove the indicated Wingnut and Projector Mount Screw to remove the Long Attachment. Slide in the Short Attachment and secure it using the Wingnut and Screw in the approximate position shown.



48

Remove the indicated Wingnut and Projector Mount Screw to remove the Long Attachment. Slide in the Short Attachment and secure it using the Wingnut and Screw in the approximate position shown.



49

Loosen the indicated Projector Mount Screw to adjust the arm by roughly 110 degrees in the forward position. Once adjusted, retighten the Screw.



50

The Projector Mount will attach to the indicated holes on the Projector.



51

Place the Projector Mount onto the Projector.



52

Adjust the arms on the Projector Mount as needed to line up all connection points.



53

Install the Projector Mount onto the Projector using (3) Projector Mount Screws and (3) Washers.

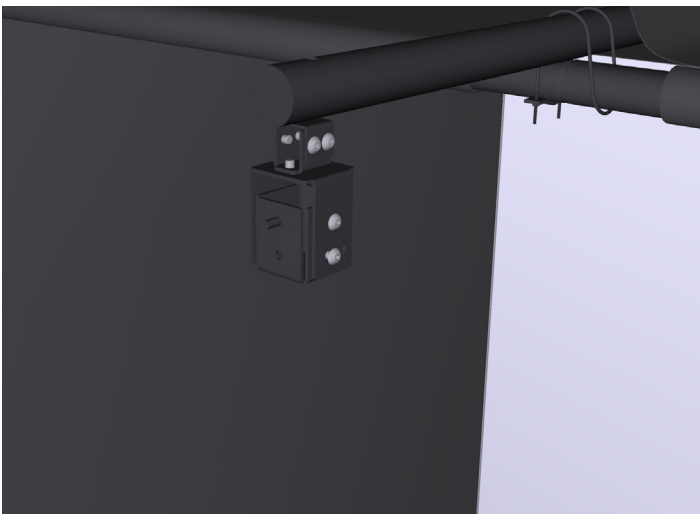

54

Align and attach the Mounting Bracket to the gimbal mount on Pole (F) using (4) Projector Mount Screws.

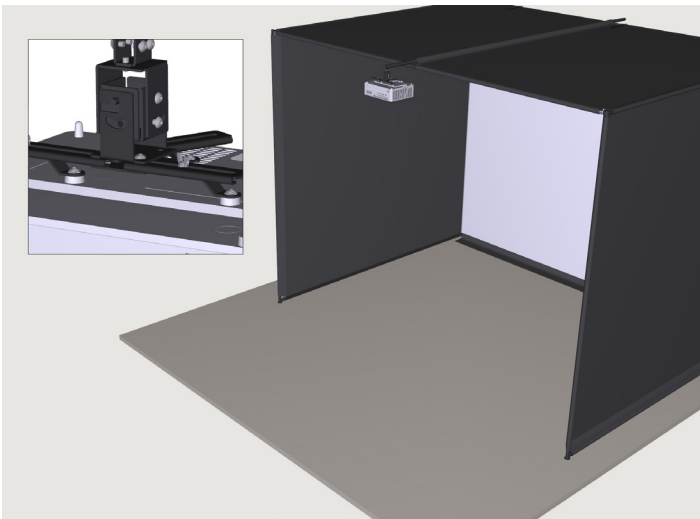

55

Hang the Projector Mount onto the Mounting Bracket as shown.

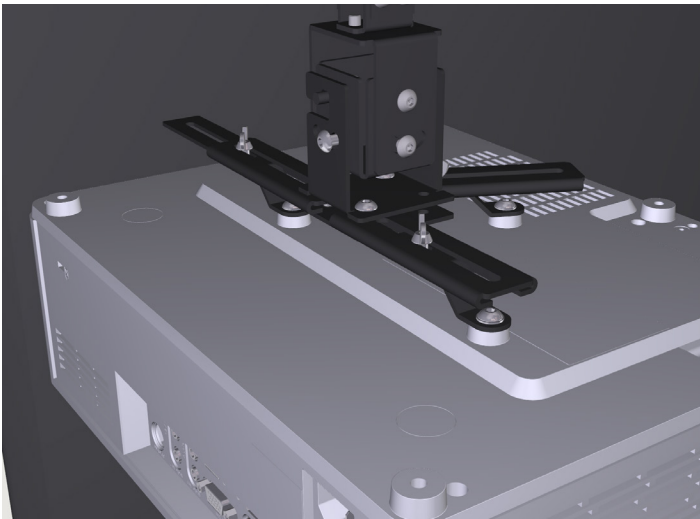

56

Attach the Projector Mount to the Mounting Bracket using (2) Projector Mount Screws.



57

The following steps will walk you through the positioning of the SkyTrak+ and Shield.
Note: The SkyTrak+ and Shield are not included with your purchase of the Golf Simulator Par 5 Short Enclosure.



58

Fasten (3) Plastic Leveling Feet onto the Shield using (3) M8 Nylon Wing Nuts. Adjust the Leveling Feet to position the SkyTrak+ at the same height as the mat.



59

Position the Shield centered with the opening facing the golf ball and turf as shown.



60

Insert the SkyTrak+ into the Shield. Ensure the laser on the SkyTrak+ is facing the opening of the Shield.

Assembly

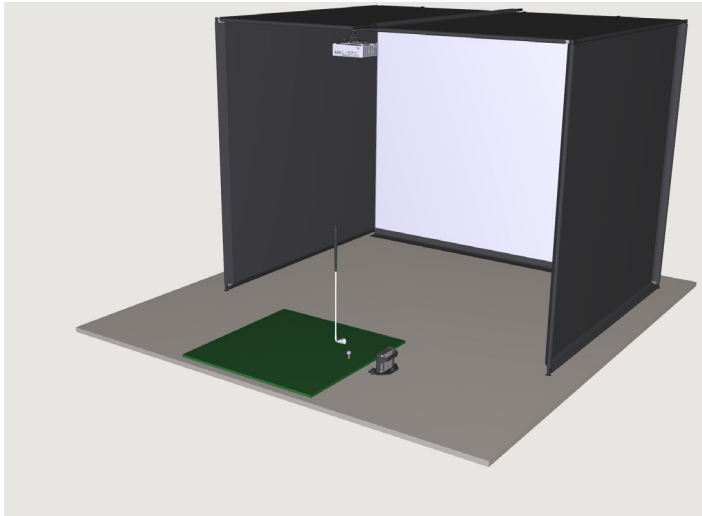

61

WARNING: Ensure the Projector is not in the path of the golf club when it is swung.

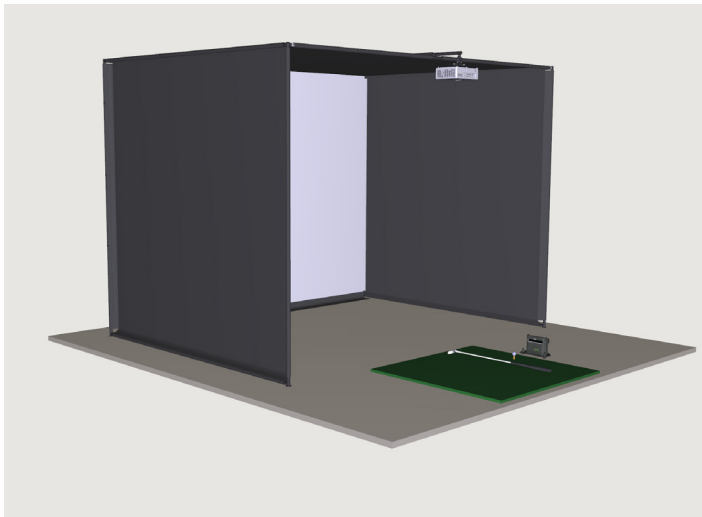

62

Congratulations, this completes the assembly of the Golf Simulator Par 5 Long Enclosure.